

Product Image

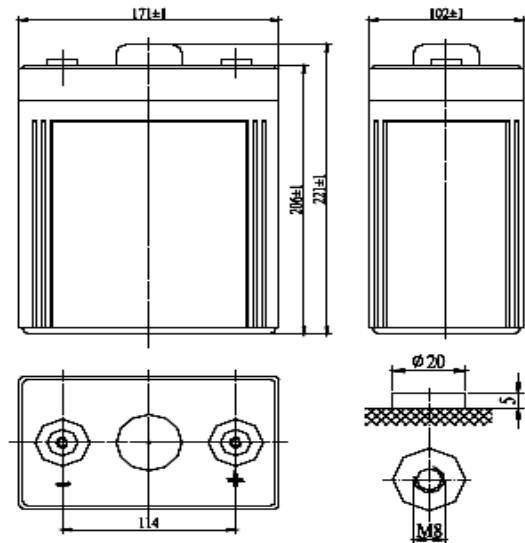

Product Dimensions



Characteristics

Nominal Voltage		2V
Nominal Capacity (10 hour rate)		80Ah
Capacity 25°C (77 °F)	20 hour rate (4.2A)	84.8Ah
	5 hour rate (14.2A)	70.6Ah
	1 hour rate (44A)	44Ah
Internal Resistance	Full Charged Battery 25°C	≤2mΩ
Capacity affected by Temperature (10 hour)	40°C (104 °F)	102%
	25°C (77 °F)	100%
	0°C (32 °F)	85%
	-15°C (5 °F)	65%
Self-Discharge 25°C (77 °F) Capacity	after 3 month storage	90%
	after 6 month storage	80%
	after 12 month storage	62%
Charge (Constant Voltage) 25°C (77 °F)	Float	Initial Charging Current Less than 20A Voltage 2.24-2.28V
	Cycle	Initial Charging Current Less than 20A Voltage 2.33-2.37V

Packaging

Battery Dimensions	Length	171mm
	Width	72mm
	Height	206mm
	Total Height	226mm
Box Dimensions	Length	224mm
	Width	187mm
	Height	261mm
Quantity Per Box		2 PC per box
Net weight Per Cell		5.6 kg ±200g
Net weight Per Box		11.2kg
Gross Weight		11.6kg

Discharge Constant Current per Cell (Amperes at 77°F/25°C)

F.V/Time	5min	10min	15min	30min	45min	1h	2h	3h	5h	8h	10h	20h
1.60V	289.0	185.8	154.8	103.2	74.0	63.8	28.2	27.5	18.7	12.3	11.0	5.83
1.65V	283.7	182.4	152.0	101.3	72.7	62.6	27.6	27.0	18.4	12.1	10.8	5.72
1.70V	278.5	179.0	149.1	99.4	71.3	61.5	27.1	26.5	18.0	11.9	10.6	5.62
1.75V	273.2	175.7	146.3	97.6	70.0	60.3	26.6	26.0	17.7	11.6	10.4	5.51
1.80V	262.7	168.9	140.7	93.8	67.3	58.0	25.6	25.0	17.0	11.2	10.0	5.30

Discharge Constant Power per Cell (Watts at 77°F 25°C)

F.V/Time	5min	10min	15min	30min	45min	1h	2h	3h	5h	8h	10h	20h
1.60V	556.3	357.6	297.9	198.6	142.5	122.8	54.2	52.9	36.0	23.7	21.2	11.2
1.65V	546.2	351.1	292.5	195.0	139.9	120.6	53.2	52.0	35.3	23.3	20.8	11.0
1.70V	536.0	344.6	287.1	191.4	137.3	118.3	52.2	51.0	34.7	22.9	20.4	10.8
1.75V	525.9	338.1	281.7	187.8	134.7	116.1	51.3	50.1	34.0	22.4	20.0	10.6
1.80V	505.7	325.1	270.8	180.6	129.6	111.7	49.3	48.1	32.7	21.6	19.3	10.2

Note The above data are average values, and can be obtained within 3 charge/discharge cycles. These are not minimum values. Cell and battery designs/specifications are subject to modification without notice. Contact **US** for the latest information.

Performance Characteristics

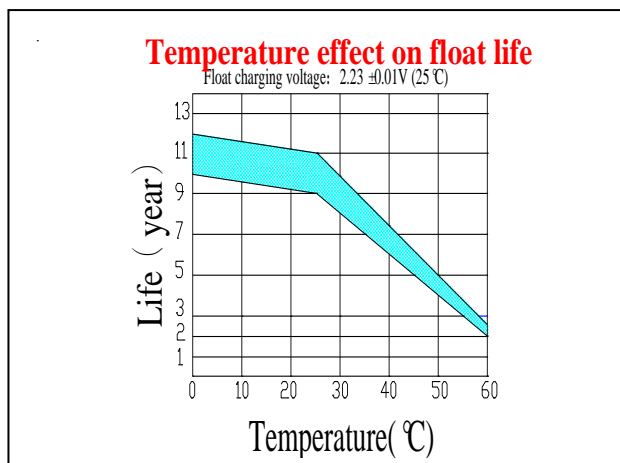
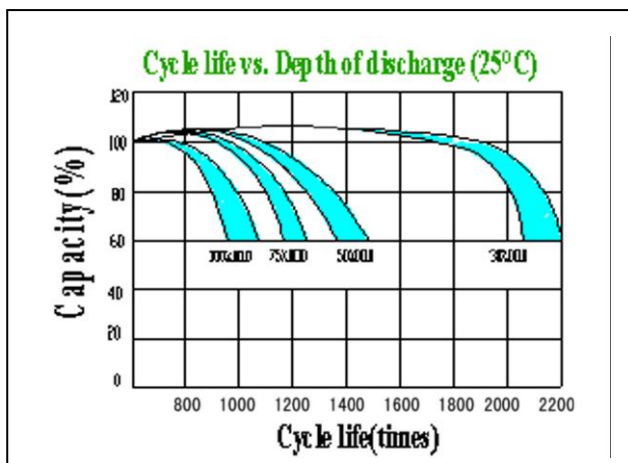
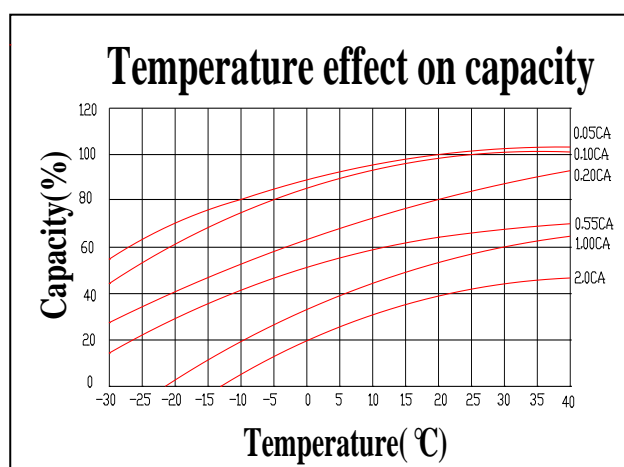
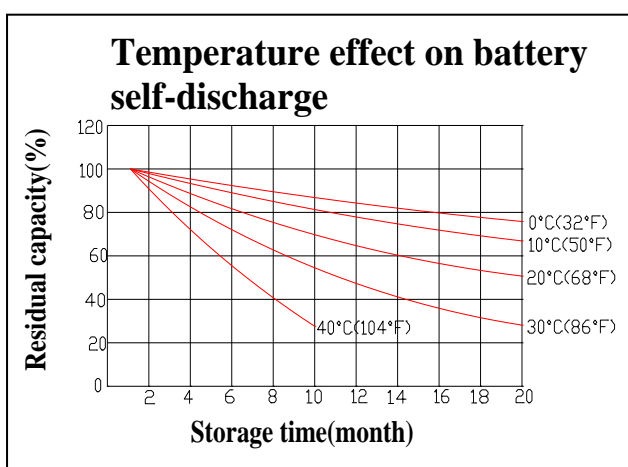
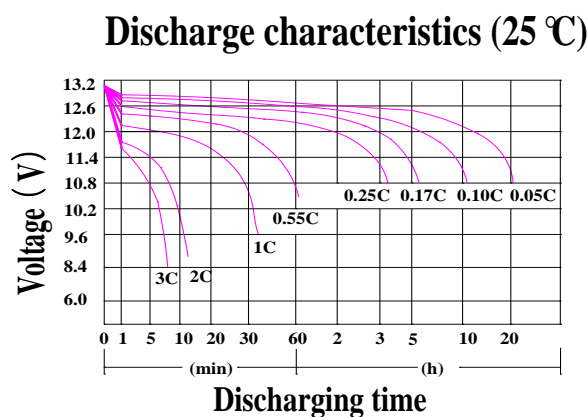
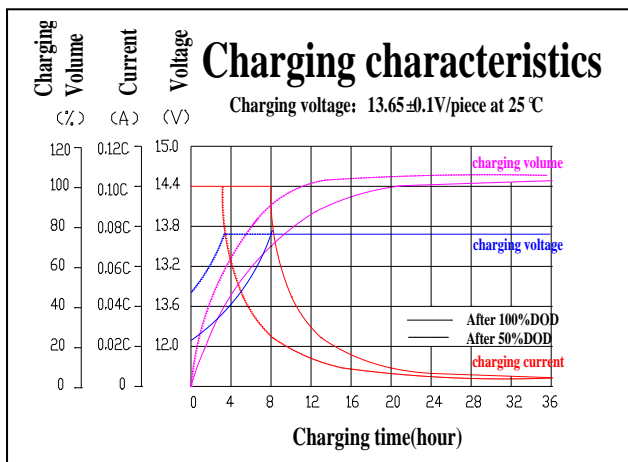

Battery Construction

Component	Positive plate	Negative plate	Container	Cover	Safety valve	Terminal	Separator	Electrolyte
Raw material	Lead dioxide	Lead	ABS	ABS	Si-Rubber	Lead	Fiberglass	Sulfuric acid